



PELLET STOVE  
"COMMO"

INSTALLATION, OPERATION AND MAINTENANCE MANUAL



**Pellet → woody biomass → biofuel**

**The heating devices (hereinafter referred to as the “stoves”) of ALFA PLAM (hereinafter referred to as ALFA PLAM) are made and tested in accordance with the safety measures of the applicable regulations of the European Community.**

**This Manual is intended for the stove users, installers, operators and persons responsible for the maintenance of the stoves shown on the first page of the Manual.**

**If you have any questions related to this Manual, please contact the stove manufacturer or an authorized service centre. In such a case, you should always state the number of the paragraph or chapter related to the respective subject, i.e. the unclear subject.**

*Any printing, translation and reproduction, even partial, of this Manual is subject to the approval of ALFA PLAM, which means that the said activities must be approved by ALFA PLAM. The technical information, figures and specifications in this Manual must not be provided to any third party.*

### **IMPORTANT WARNINGS!**

**IMPORTANT: The connection of the device to the power supply installation must be compulsorily performed by qualified and authorized persons in accordance with the valid legal regulations.**

**This device has not been foreseen for application by persons (including children) with reduced physical, motor and mental abilities or persons with limited knowledge and experiences without the presence of persons responsible for their safety i.e. care.**

**Children must not play with these types of devices.**

#### **DUAL COMBUSTION SYSTEM**

The flame obtained by the normal combustion of wood in the stove emits the same quantity of carbon dioxide (CO<sub>2</sub>) that would be released as a result of the natural decomposition of wood.

The quantity of carbon dioxide (CO<sub>2</sub>) obtained by the combustion or decomposition of plant mass corresponds to the quantity of carbon dioxide (CO<sub>2</sub>) that plant mass is capable of obtaining from its surroundings and transforming it into oxygen for air and carbon of the plant during its whole life.

The use of non-renewable fossil fuels (coal, oil, gas), contrary to what happens with wood, releases into the atmosphere enormous quantities of carbon dioxide (CO<sub>2</sub>) accumulated for millions of years, thus causing the

greenhouse effect. The use of wood as fuel is therefore perfectly balanced with the environment because wood as renewable fuel is in ecological harmony with nature.

These goals are completely accomplished through the principle of clean combustion and this is why the designs of the ALFA PLAM products are based on this principle.

What does clean combustion mean and how does it take place?

The control and adjustment of primary air and the introduction of secondary air generate, i.e. cause secondary combustion or the so-called post-combustion that produces the secondary flame which by its nature is brighter and stronger than the main or primary flame. The addition of new oxygen (through the introduced air) enables the additional combustion of gases that were not completely combusted. This significantly increases the thermal effect and decreases the harmful emissions of carbon monoxide (CO) because the incomplete combustion is reduced to a minimum. These are the basic characteristics of the stoves and other products of ALFA PLAM.

## **0.0 TECHNICAL CHARACTERISTICS OF THE STOVE**

### **TECHNICAL CHARACTERISTICS OF THE STOVE**

#### **1. Dimensions:**

-Width.....	574 mm
-Depth.....	620 mm
-Height.....	1200 mm
2. Diameter of the forge hood connection.....	80 mm
3. Diameter of the external air intake.....	100 mm
4. Height from the floor to the forge hood connection axis.....	350 mm
5. Maximum power.....	20,78 KW
6. Maximum power by radiating.....	2,92 KW
7. Maximum power of the boiler.....	17,86 KW
8. Maximum consumption.....	5,05 kg/h
9. Degree of utilization with the maximum power.....	86,09 %
10. Minimum power.....	7,02 KW
11. Minimum power by radiating .....	1,52 KW
12. Minimum power of the boiler .....	5.5 KW
13. Minimum consumption .....	1,7 Kg/h
14. Degree of utilization with the minimum power.....	86,69 %
15. Minimum draught.....	5 Pa

16. Optimal draught.....	12 Pa
17. Heating volume.....	275-350 m3
18. Capacity of the funnel-shaped fuel tank.....	45 kg
19. Maximum operating time with a full tank .....	30 h
20. Minimum operating time with a full tank.....	10 h
21. Maximum output power.....	450 W
22. Voltage/frequency .....	230V/50Hz
23. Weight:	
-Net.....	196 kg
-Gross.....	225 kg

## **1.0 THE PURPOSE OF THIS MANUAL**

The purpose of this Manual is to enable the user to take all necessary measures and prepare all necessary equipment and materials in order to ensure the safe and proper exploitation i.e. use of the stove.

### **1.1 UPDATING**

This Manual presents the state-of-the-art at the moment the stove is placed on the market. Therefore, ALFA PLAM does not take into account the stoves already on the market with appropriate technical documents, and considers them faulty or inadequate after any modifications, adaptations or application of new technologies to newly launched machines.

The contents of this Manual must be read and study very carefully. You should strictly adhere to all the instructions given in this Manual. All the information included in this booklet is necessary for the installation, use and maintenance of your stove.

Therefore, this Manual must be carefully kept because of its instructions that may be necessary if any problem or ambiguity arises.

*If the stove is handed over or resold to another person, the new owner must also be given this Manual.*

If you lose this booklet, you can ask the manufacturer for a new one.

## **2.0 THE RESPONSIBILITY OF THE MANUFACTURER**

Upon publishing this Manual, ALFA PLAM **will not accept any civil or legal responsibility, either direct or indirect, due to:**

- **Accidents occurred due to the non-observance of the standards and specifications stated in this Manual,**
- **Accidents occurred due to the improper operation or use of the stove by the user,**
- **Accidents occurred due to any modifications and repairs not approved by ALFA PLAM,**
- **Poor maintenance,**
- **Unpredictable events,**
- **Accidents occurred due to the use of spare parts that are not original spare parts or that are not intended for these models of the stove.**

**The installer of the stove shall take the full responsibility for the installation.**

### **2.1 THE BASIC CHARACTERISTICS OF THE USER**

The user must have the following basic characteristics:

- To be a responsible adult,
- To have certain technical knowledge needed for the routine maintenance of the electric and mechanical components of the stove.

**CHILDREN MUST NOT APPROACH THE STOVE OR PLAY WITH IT WHILE IT IS IN OPERATION.**

### **2.2 THE TRANSPORTATION AND USE OF THE STOVE – HANDLING**

During the use of the stove care should be taken that the stove is not leaned forward because the centre of gravity of the stove is oriented forward.

While moving the stove, which must be carried out absolutely safely, ensure that the forklift truck has a carrying capacity that is higher than the weight of the stove it should lift. Avoid twitches and abrupt movements.

**ALL THE PACKAGING MATERIAL SHOULD BE REMOVED AWAY FROM THE REACH OF CHILDREN AS THE MATERIALS CONTAINED IN THE PACKAGING MAY CAUSE SUFFOCATION. THESE INCLUDE PLASTIC BAGS, FILMS, STYROFOAM, ETC.**

### **2.3 THE RESPONSIBILITY OF THE INSTALLER**

**The responsibility of the installer is** to perform all the checkups of the flue piping, air intake/supply, as well as all the solutions required for the installation (incorporation) of your stove.

**The responsibility of the installer is** to ensure that the stove is in compliance with local regulations applicable in the place where the stove is installed (incorporated).

**The use of the stove** must be in accordance with the instructions given in this Manual for use and maintenance, as well as with all the safety standards prescribed by local legal regulations applicable in the place where the stove is installed (incorporated).

The installer must **verify (confirm)**:

- The type of the stove that is being installed,
- Whether the room in which the stove is being installed is appropriate, which is expressed as the minimum size of the room required for the installation as prescribed by the stove manufacturer,
- Instructions of the heat generator manufacturer, related to the requirements of the smoke discharge system (smoke discharge ducts and pipes),
- The internal cross section of the chimney, material the chimney is made of, cross-sectional uniformity, whether there are any obstacles and barriers in the chimney,
- The height and vertical extension of the chimney,
- The height above the sea level at the place of installation/incorporation,
- The existence and suitability of a wind resistant protective cover of the chimney,
- The possibility of providing the external air intake and the size of required openings,
- The possibility of the simultaneous use of the stove which is to be installed, together with the other equipment already existing in that place.

If the results of all the checkups are positive, then the installer may proceed with the incorporation/installation of the stove. The instructions provided by the stove manufacturer, as well as the fire prevention standards and safety standards must also be observed.

When the installation is completed, the system must be put into a trial operation for at least 30 minutes in order to check up all the packing and seals of the system.

When the incorporation and significant details are completed, the installer is obliged to provide the client with the following:

- The Use and Maintenance Manual issued by the stove manufacturer (if such a manual has not been delivered with the stove),
- The documents required for the compliance with existing standards.

### **3.0 THE INSTALLATION – INCORPORATION OF THE STOVE**

**The user shall be fully responsible for the works executed at the incorporation site.**

Before putting the stove into operation, the installer must meet all legal safety standards, in particular:

- Ensure that the stove installation is in accordance with local, national and European regulations,
- That it fulfils the requirements stated in this document,
- That the installation of the flue piping and air intake corresponds to the type of the installed stove,
- That the electric connections must not be executed with the use of temporary and/or non-insulated electric cables,
- Check the efficiency of the electrical system grounding,
- Always use the personal protective equipment and all the protective means prescribed by applicable local regulations,
- **Always ensure sufficient servicing space required for any maintenance and repairs of the stove.**

### **3.1 PLACING THE STOVE**

We advise you to unpack the stove only when it is put in the place where it is to be installed.

The stove stands on plastic legs with cast-in screws M10 (4 pieces) screwed into the base of the stove. Nuts M10mm are screwed onto the screws up to the plastic part. The legs are also maximally screwed, up to the base of the stove. When you unpack the stove and bring it to the spot on which it is to be installed, unscrew all the legs to obtain the total height from the floor to the stove base i.e. to ensure that the legs are protruded from the stove base for around 25mm. When you finish levelling the stove which should stand horizontally, tighten the nuts while holding the plastic part of the leg with your hand. Tighten the nuts using spanner 17 so that they reach the stove base. The height of around 25mm from the floor to the stove base is needed for air circulation and better stove cooling. In this way, you will protect the stove against overheating and extend its service life.

If the surrounding walls and/or floor are made of materials that are **not heat resistant**, appropriate protection should be used consisting of incombustible insulation material.

Always ensure a safe distance (around 35/40 cm) between the stove and your furniture, home appliances, etc. In order to protect the floor, if it is made of combustible material, we suggest that you put on the floor, under the stove, a metal plate with a thickness of 3 to 4 mm that would protrude for 30 cm ahead of the stove front.

**The stove must be placed at a distance of at least 25 cm from the surrounding walls.** Always leave at least 15 cm between the back of the stove and the wall in order to ensure the proper circulation of air, i.e. to allow air to properly flow through this space.

If the stove is to be placed in a kitchen with a ventilation grid, or if it is to be placed in rooms with solid fuel heat generators (such as wood burning stoves), always ensure that the quantity of the inlet air (into the kitchen or room) is sufficient to provide the safe operation of the stove.

If the smoke discharge channel should pass through the ceiling, the ceiling should have proper thermal insulation made of incombustible insulating material. Once the stove is placed, it should be levelled with the use of the adjustable legs.

#### **DANGER**

The smoke discharge fittings **MUST NOT** be connected to:

- The flue pipe used by another heat generator (water heaters, stoves, fireplaces, kitchen stoves, etc.),
- To the air exhaust system (grids, vents, etc.), even if the system is inserted in the pipe discharge.

#### **DANGER**

It is prohibited to install air circulation (draught) shut-off valves (flaps, valves that may prevent air circulation i.e. that may prevent draught).

#### **CAUTION**

If the smoke discharge path produces poor draught i.e. poor air circulation (if the path has numerous bends, inappropriate smoke discharge end, narrowing, etc.), the smoke discharge can be bad, i.e. inappropriate.

The smoke discharge system functions on the basis of the negative pressure and mild pressure of the flue pipe. It is very important that the smoke discharge system is sealed. This requires the application of a pipe smooth inside.

When the flue pipe is to be placed through the walls and roof, the plan and structure of the room should be thoroughly analysed and studied first, so that the pipe may be placed properly in accordance with the fire prevention standards.

First, it should be ensured that there is sufficient combustion air in the room where the stove is located. Occasional inspection is recommended to ensure that combustion air is properly supplied to the biofuel combustion chamber. The stove operates on 230 V – 50 Hz. Ensure that the electric cable is not entangled under the stove, that it is away from hot places and that it cannot come in contact with any sharp edge that could cut it. If the stove is electrically overloaded, this may shorten the service life of the electronic parts of the stove.

**Never turn off power supply by pulling out the plug while flames are still burning in the stove. This may jeopardize the proper operation of the stove.**

### ***3.2 THE SMOKE DISCHARGE SYSTEM***

The smoke discharge must be executed in accordance with the existing standards. The flue pipe should be thoroughly sealed. See Figures 1 to 7.

For smoke discharge, classic brick chimneys can be used, or chimneys may be made of pipes that must be thoroughly insulated (double wall) and sealed in order to prevent condensation in them.

The discharge pipe must not be connected with other systems of any type, such as the systems for discharging smoke from the combustion chamber, exhaust grid or air distribution systems, etc. Furthermore, the flue pipe must not be located in closed or semi-closed rooms such as garages, narrow corridors, under closed huts or any other place where smoke may appear. When the stove is to be connected to the flue piping, a professional chimney sweep should be called to verify that there are no even tiniest cracks or fissures in the chimney. If the smoke discharge chimney has any cracks, the flue pipe must be wrapped in new material in order to ensure proper functioning.

For this purpose, rigid pipes made of non-ferrous steel (with a minimum thickness of 1.5 mm) can be used, or pipes made of stainless steel (with a minimum thickness of 0.5 mm).

The smoke discharge system (chimney) made of metal pipes must be grounded in accordance with applicable standards and legal regulations. **Grounding is prescribed by the law.**

**This grounding connection must be independent of the stove grounding.**

The flue pipe must be made in compliance with the standards regarding the dimensions and materials used for its construction (Figure 1).

- A) Wind resistant chimney top
- B) Maximum cross section of 15 x 15 cm or a diameter of 15 cm, maximum height of 4-5 m.
- C) Seal
- D) Inspection – control opening.

Flue pipes in bad condition or made of inappropriate material (asbestos cement, galvanized sheet metal, etc. with coarse and rough or porous surfaces) are illegitimate and they jeopardize and hamper the proper operation of the stove.

Smoke can be discharged through a classic flue pipe (see the figures below) provided that the following regulations are met:

- Check the maintenance condition of the flue pipe or the chimney. If the discharge flue pipe is old, it should be replaced by a new one. If the chimney is damaged, it should be repaired or refurbished by inserting a steel pipe properly insulated with mineral wool.

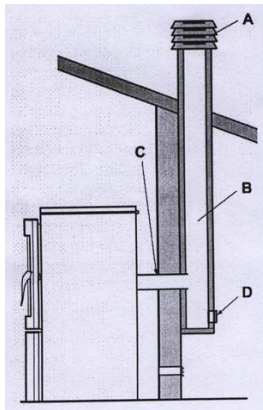

Figure 1

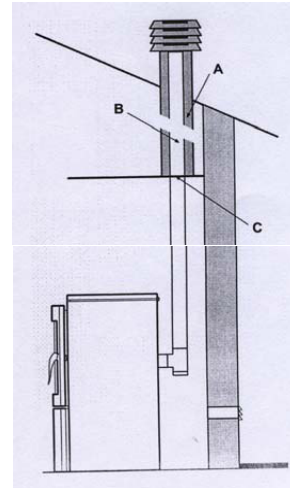

Figure 2

- Smoke is discharged directly into the flue pipe (chimney) only if its cross section is up to 15 x 15 cm or if its diameter is up to 15 cm and if it has a cover for the purposes of inspection and cleaning.
  - **If the cross section of the chimney is larger** than 15x15cm or its diameter is larger than 15cm, the possible control of increased draught (decreasing) in the chimney can be performed in three ways:
    1. If there is an opening for the purpose of cleaning at the bottom of the chimney, it should be partially opened.
    2. A steel pipe with a diameter of 10 cm should be inserted into the chimney if you have elements for such a refurbishment of the chimney.
    3. By the regulation of certain parameters in the stove. This regulation can be performed only by an authorized service centre of Alfa plam.
  - Ensure that the connection for the house chimney is properly sealed.
  - Avoid any contact with easily combustible material (such as wooden beams), and in any case these should be insulated with fire resistant material (see Figure 2).
- A) Mineral wool  
 B) Steel pipes  
 C) Partition plate.

The stove is designed for the connection to the chimney with flue pipes whose diameter is 80mm. If the standard chimney is not used but a new one is being constructed or the existing chimney is being refurbished, use insulated stainless steel pipes (double wall) with a diameter in accordance with Table 1. The use of flexible pipes is not allowed.

SYSTEM TYPE	DIAMETER mm	SYSTEM ASSESSMENT
Pipe shorter than 5 m	80	acceptable
Pipe longer than 5 m	100	obligatory
Installation at places where the elevation above the sea level is higher than 1,200 meters	100	recommendable

Table 1

When you use a connecting pipe between the stove and the discharge flue pipe, you must also use a "T" coupling (as it is shown in Figures 5 and 6), with the cover for the purpose of cleaning (plug) next to the stove. The application of this "T" coupling must enable the collection of ashes generated inside the pipe and cleaning of the discharge flue pipe from time to time without removing the pipe. The smoke is under mild pressure. Because of this, it is necessary to check if the opening i.e. the cover (plug) for cleaning the smoke discharge system is perfectly sealed and if it remains perfectly sealed after each cleaning. Ensure that the assembly is carried out in the same order and check the condition of the seal.

The installation of the flue pipes should be performed in accordance with Figure 7.

It is strictly recommended to avoid using horizontal extensions or elongations and if this is necessary, ensure that the pipe is not counter leaned but that it has an inclination of at least 5%. The horizontal extensions must never be longer than 3 m.

It is not recommendable to connect the flue pipe directly to the stove with a horizontal extension longer than 1 m. See Figures 4, 5, 6 and 8. It is necessary to put a vertical extension of Ø 80mm with a length of at least 1-1.5 m after the "T" claw, and only after that proceed to a horizontal extension of Ø 80mm and a vertical extension of Ø 80 or Ø 100mm depending on the height of the flue pipe (chimney), as it is shown in Table 1.

Figure 3 on the left shows how the end (top) of the chimney should look like when there are two chimneys one next to the other, and Figure 3 shows how the end should not be executed.

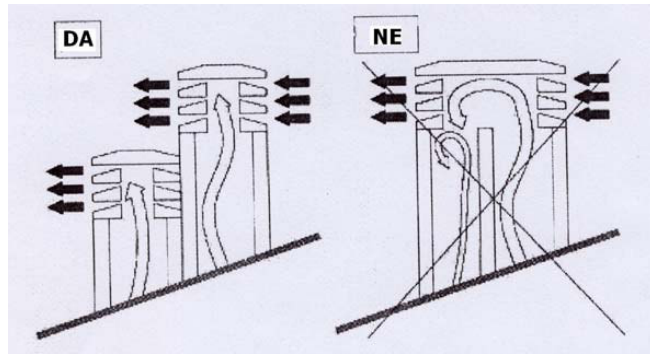

Figure 3

**3.3 THE INSULATION and DIAMETER OF THE OPENINGS (Holes) ON THE ROOF (or on the Wall)**

Once the position of the stove is determined, it is necessary to make a hole i.e. an opening the flue pipe should pass through. This varies depending on the type of installation, diameter of the flue pipe (see Table 1) and the type of the wall or roof the flue pipe should pass through. See Table 2. The insulation must be made of mineral wool with nominal density higher than 80 kg/m<sup>2</sup>.

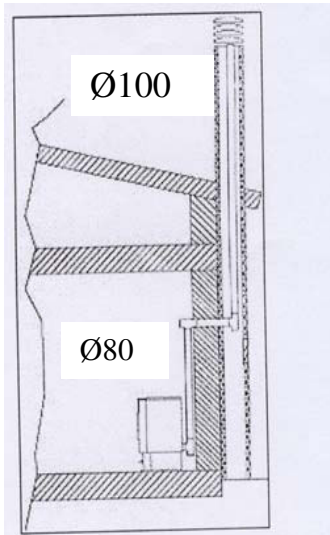

Figure 4

1. Armature 80>100
2. T-shaped pipe fittings

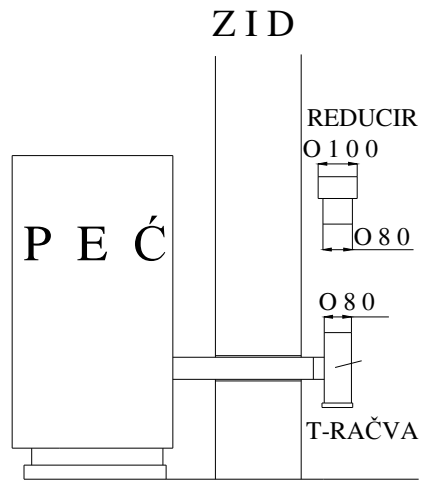

Figure 5

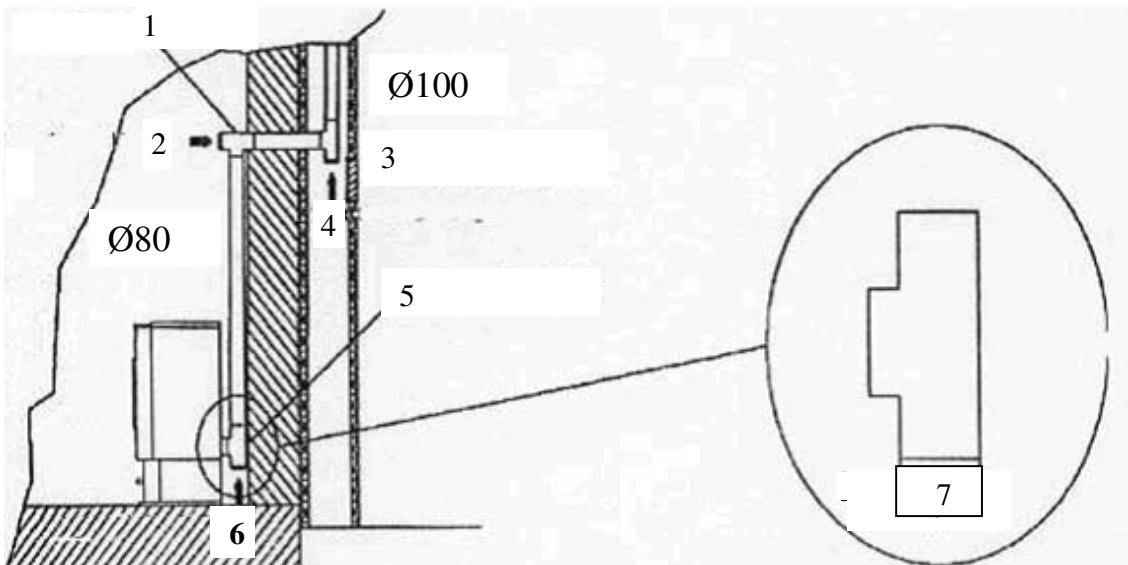

Figure 6

1. T-shaped pipe fittings – T-shaped pipe coupling
2. Cleaning direction
3. Opening, window for servicing / inspection
4. Cleaning direction
5. T-shaped pipe fittings – T-shaped pipe coupling
6. Cleaning direction
7. Sealed cover for the purpose of cleaning (plug)

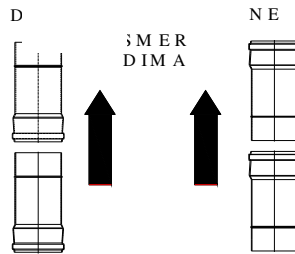

Figure 7. Flue pipe installation

It is recommended that knee-shaped flue pipes are three-fold to minimise the resistance of smoke passage. It is also recommended that one of the used knees and positioned in a suitable place has an opening for easier and more efficient cleaning of flue pipes. See image 7a.



Figure 7a

Insulation thickness mm		Flue pipe diameter (mm)	
		D.80	D.100
		Diameters of holes (openings) that should be made (mm)	
Walls made of wood or combustible anyway, or parts that are combustible	100	150	170
Concrete wall or roof	50	100	120
Brick wall or roof	30	100	120



Table 2: Insulation thickness for the part of the system that passes through wall or roof

First of all, it is necessary to provide PERFECT CIRCULATION of air (draught) in the flue pipe which must be free of any obstacles such as narrowing or angles. Any shifts of the axis must have one path inclined with a maximum angle of 45 degrees from the vertical, and the best solution is 30 degrees. These shifts should be best performed near the wind resistant top of the chimney.

In accordance with **regulations (the wind resistant top of the chimney, distances and stove placing)**, the distances shown in Table 3 must be met:

Roof inclination	Distance between the roof ridge cover and the chimney	Minimum height of the chimney measured at the upper opening (at the chimney outlet)
$\alpha$	Distance in meters	Height in meters
$15^{\circ}$	Less than 1.85 m More than 1.85 m	0.50 above the roof ridge cover 1.00 meter from roof pitch
$30^{\circ}$	Less than 1.50 m More than 1.50 m	0.50 above the roof ridge cover 1.30 meters from the roof pitch
$45^{\circ}$	Less than 1.30 m More than 1.30 m	0.50 above the roof ridge cover 2.00 meters from the roof pitch
$60^{\circ}$	Less than 1.20 m More than 1.20 m	0.50 above the roof ridge cover 2.60 meters from the roof pitch

Table 3

**However, it is obligatory to provide an initial vertical extension (elongation) of 1.5 m (minimum) in order to provide a proper smoke discharge.**

### **3.4 THE INTAKE OF COMBUSTION AIR (Figure 8)**

The air necessary for combustion, taken from the surroundings, must be regenerated through a ventilation grid located on the wall of the room and turned outwards. This will provide a better combustion and a lower consumption of biofuel pellets. It is not recommendable that external air is sucked directly through the pipe, because it would decrease the efficiency i.e. performance of combustion. On its external side, the ventilation opening must be equipped with a ventilation grid as protection against rain, wind and insects.

This opening must be made on the external wall of the room in which the stove is located.

**The intake, i.e. supply of combustion air from garages, warehouses for combustible materials or fire hazard rooms, is prohibited.**

**The hole, i.e. opening for external input combustion air must not be connected with the use of pipes.**

**If the room also has any other heating equipment, the intake of combustion air must provide the amount of air necessary for the proper operation of all the devices.**

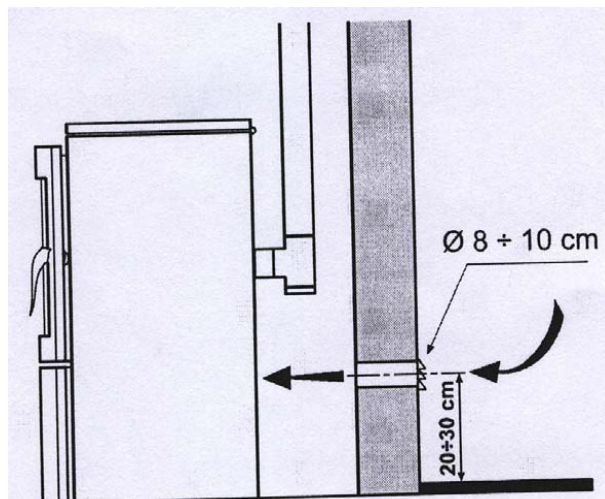

Figure 8. Minimum distances for the installation of the ventilation grid

For the proper and safe installation of the ventilation grid, see the data in Table 4. These are minimum distances from any air space or smoke discharge. This value can change the configuration of air pressure. These distances should correspond to the sequence in order to ensure, for example, that an open window intakes external air, taking it away from the stove itself.

The ventilation grid must be installed at least

1 m	under	the door, window, flue pipe, air chambers, etc.
1 m	horizontally from	
0.3 m	above	
2 m	away from	smoke outlet

Table 4: Minimum distances for the intakes of combustion air

### **3.5 CONNECTION TO THE ELECTRIC POWER SUPPLY**

These stoves should be connected to the electric power supply. Our stoves have electric cables suitable for medium temperatures. If the cable should be replaced (e.g. because it is damaged), please consult our authorized technical personnel, our experts. Before you connect the stove to the electric power supply, ensure that:

- The characteristics of the electric system correspond to the data i.e. specification stated on the nameplate of the stove.
- The smoke discharge system, if it is metal, must have an operational grounding connection in accordance with applicable standards and legal regulations. **Grounding is prescribed by the law.**
- The electric cable must never reach a temperature which is by 80<sup>0</sup> C higher than the ambient temperature. If you want to obtain a direct connection to voltage, you should install a bipolar switch with a minimum clearance of 3 mm between the contacts, with the dimensions for electric load shown in the nameplate, and in accordance with applicable standards. Yellow-green grounding cables must not be switched off by the switch. When the stove is installed at its place, the bipolar switch or the socket must be easily accessible.
- If the stove will not be used for a longer period, switch it off from the power supply or turn the switch into a switched off (0) position. In the case of any breakdown or improper operation, switch the stove off immediately or turn the switch into the switched off position (0) and contact the authorized service centre.

### **4.0 IMPORTANT INSTRUCTIONS**

THESE ARE IMPORTANT OBLIGATORY INSTRUCTIONS FOR THE SAFETY OF PEOPLE, ANIMALS AND PROPERTY.

We would like to inform the stove installer on some general instructions that he must adhere to in order to install the stove properly. These standards are required, but not fully. For further and more precise information, read the remaining part of this Manual.

- Connect the stove to a grounded socket. Figure 9
- Put the switch on the back of the stove in position 1. Figure 10
- Do not allow children and pets to come near the stove.
- Use only biofuel pellets, and not any other types of fuel.
- Inform all the users on possible risks and dangers and teach them how to handle the device.
- If the stove is installed on a wooden floor, it is recommendable to insulate its stand.

The stove functions with a negative pressure combustion chamber. **Because of that, ensure that the flue pipe is thermally sealed i.e. insulated.**

**When the stove is lit for the first time, a smaller quantity of paint (not harmful to health) covering the stove will evaporate because of the painting process stabilization. Ventilate the room in order to remove these vapours from it.** Ventilate the room in order to remove vapours.

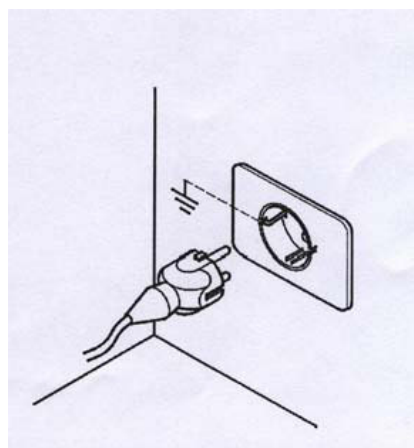

Figure 9

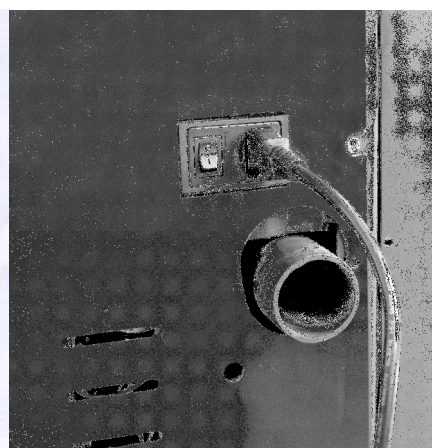

Figure 10

### **5.0 WARNING OF THE SAFETY MEASURES FOR THE MAINTENANCE STAFF**

Besides being obliged to adhere to all safety measures, maintenance workers must:

- Always use security devices and personal protective equipment.
- Turn off the electric power supply before they start working.
- Always use adequate tools.
- Ensure that the stove and ash are completely cool before starting any operations on the stove.  
Especially, take care that the handles are cool before you touch them.
- **NEVER START UP THE STOVE** even if only one of the security devices is faulty, improperly set or does not function.
- Do not make any modifications for whatever reason except those allowed and explained by the manufacturer.
- Always use original spare parts. Never allow the components to completely wear out before you replace them. Replacing a worn out part i.e. component of the stove before it breaks down contributes to the prevention of injuries caused by an accident due to a sudden breakdown i.e. failure of the component that may cause serious human injuries and damages to the property around the stove.
- Clean the firebox before lighting the stove.
- Check whether any condensation has occurred. If any condensation occurs, this indicates that there is some water from smoke cooling. We recommend you to find possible causes in order to establish a normal and proper work of the stove.

### **5.1 WARNING OF THE SAFETY MEASURES FOR THE USER**

The place where the stove is to be put, called the installation place, must be prepared in accordance with local, national and European regulations.

The stove is a "heating machine" and **during its operation, its outer surfaces are very hot i.e. they have extremely high temperatures**, or they are rather hot.

This stove is designed to combust fuel made of pressed wood mass (pellets with a diameter of 6 mm to 7 mm, length of about 30 mm and maximum moisture of 8-9%).

**Because of this, during the use of the stove it is very important to observe the following warnings:**

- Do not approach and touch the glass on the door, there is a RISK OF BURN INJURIES
- Do not approach and touch the flue pipe, there is a RISK OF BURN INJURIES
- Do not perform any kind of cleaning
- **Do not open the door as the stove functions properly only when it is sealed**
- Do not remove ashes when the stove is in the operational mode
- Children and pets must be away from the stove
- ADHERE TO ALL THE REGULATIONS STATED IN THIS DOCUMENT – MANUAL.

### **In addition, for the proper use of biofuel pellets:**

- Only use fuel which is in accordance with the manufacturer's instructions,
- Always adhere to the stove maintenance plan,
- Clean the stove every day (only when the stove and ashes are cold),
- Do not use the stove if there are any failures or abnormalities, or in the case of unusual noise and/or suspected breakdowns,
- **Do not throw or pour water on the stove, even in fire fighting,**
- **Do not turn off the stove by pulling the plug out. Use the off button on the panel,**
- The stove should not be inclined as IT MAY BECOME UNSTABLE,
- Do not use the stove as a support or holder. Never leave the tank fuel cover opened,
- Do not touch the painted parts of the stove while it is in operation,
- Do not use wood or coal as fuel, but **only fuel pellet** with the following characteristics: diameter of 6-7 mm, maximum length 30 mm, maximum moisture 8-9%,
- Do not use the stove for burning garbage,
- Always perform all the operations with maximum safety measures.

### **6.0 STANDARDS FOR SAFE LIGHTING AND CLEANING THE STOVE**

- Never use gasoline, petroleum or any other combustible liquid for lighting the stove. Keep these kinds of liquid away from the stove while it is in operation,
- Never light the stove if the glass is damaged. Never hit the glass or door as you may damage them,
- While the stove is in operation, do not open the door in order to clean the glass. The glass can be cleaned only when the stove is cool, using a cotton cloth or paper towels (cloths) and a glass cleaning agent,
- Ensure that the stove is fixed well in order to prevent any movement,
- Ensure that the box for ashes is inserted and that it is completely closed, so that the door is properly leaned against the inner box,
- Ensure that the stove door is tightly closed while the stove is in operation,

- Remove ashes with a vacuum cleaner only when the stove is completely cool,
- Never clean the stove surfaces with any abrasive cleaning agents.

### **6.1 ROUTINE CLEANING and MAINTENANCE PERFORMED BY THE USER OF THE STOVE**

The use of a drum-shaped vacuum cleaner can facilitate the stove cleaning. The vacuum cleaner must have a filter which stops the vacuumed dust to go back into the room where the stove is located.

Before you start any routine maintenance, including cleaning, you should take the following safety measures:

- Shut off power to the stove before you start any works,
- Before you start any works, ensure that the stove and ash are cool,
- Vacuum the ash from the combustion chamber **every day**,
- Carefully clean the firebox with the vacuum cleaner **every day** (after every use and when the stove is cool),

#### **Always ensure that the stove and ash are completely cool.**

-FIREBOX (box-shaped) is a place where wood mass pellets burn. See Figure 11 It is recommended that the firebox should be cleaned with a vacuum cleaner after each use (when the stove is cool). After every third use, it is recommended that the firebox should be taken out for ensuring that there is no excessive ash accumulated at the bottom of the firebox. Then place the firebox back in its place, making it stable, to ensure the safe operation of the stove.

If you have any doubts, please do not hesitate to call the authorized service centre for further information and clarification, as the manufacturer does not have any insight into the installation of the stove and does not offer any warranty for the incorporation of the stove and its maintenance.

**The manufacturer shall not be liable for any damages caused by third parties.**

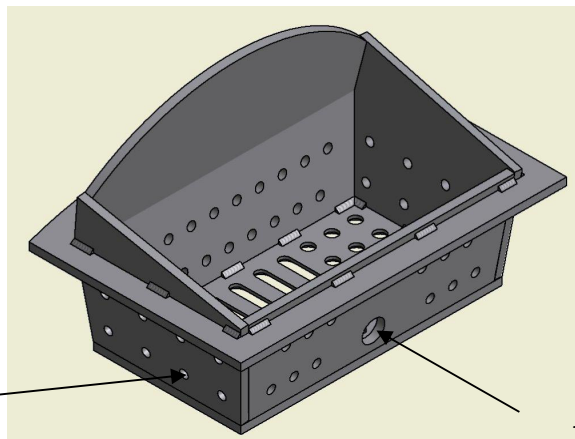

Figure 11

2. For the best performance of the stove, all the holes must be free of ash

1. Hole for entering a heating element to ignite the fuel

- ASHTRAY (if it is full, you should clean it with a vacuum cleaner or empty it):

#### **Make sure that the stove and the ash are cold**

The upper ashtray must be cleaned **every day or every other day**, with a vacuum cleaner or simply by disposal of the ash.

Ash-bin may be opened in two ways:

The first way is by turning or pulling the specially made handrails on the handrail of the ash-bin towards oneself while holding them with both hands. See image 12.

The second way is with a special key whose bent end should be inserted into the slot on the handrail and then pulled towards oneself. See image 13.

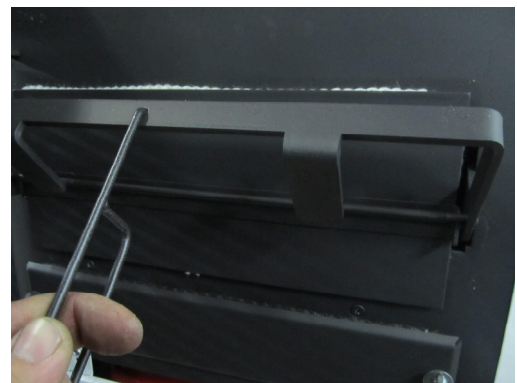

Figure 12

Figure 13

In this manner all dirt that stays inside during the combustion of pellets will be removed. Then the ash box must be properly returned to its position. Do not ever put pellets that have not burnt down in the ashtray or ash box. The lower ash box must be cleaned once in ***fifteen – twenty days***, with a vacuum cleaner or simply by disposal of the ash. During this, two butterfly nuts should be loosened. In this manner all dirt that remains inside during the combustion of pellets, will be removed.

At the same time, clean with a vacuum cleaner the flue extension of the chamber through the opening at the front side of the boiler for the lower ashtray.

Then the lower ashtray must be properly returned to its position.

- FLUE PIPE IN THE BOILER (SIDEARM HEAT EXCHANGER )

It should be cleaned by manual shaking with a special rod at each consumed 40-50kg of pellets (one full pellet tank). Previously by using the rod, lift the small round covers with an opening (two pieces) that are located on the cover of the stove on the top. The same rod can be inserted in the openings of the crank – the pins where the springs for cleanings are connected and shake them after lifting them and lowering them for few times, as shown in figure 14.

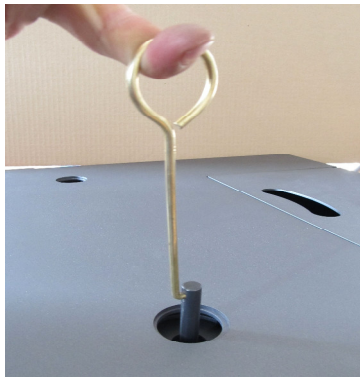

Figure 14



Figure 15

-LOWER SMOKE CHAMBER

It should be cleaned manually at each consumed 90-100 kg of pellets (two full tanks). Raise the cover of the pellet tank. In the tank, in the front upper part, under the cover, there is a button for the mechanism for cleaning the chamber. By pulling the button for the mechanism few times forward-backward, you will clean the chamber. Don't become worried if the mechanism is a bit difficult to move or if it scratches. In this manner it performs the cleaning of the chamber.

- FLUE PIPES IN THE BOILER, (UPPER HEAT EXCHANGER IN THE BOILER)

It has to be cleaned after a consumption of 200 – 250kg of pellets. Open the door of the boiler and clean the inside of the heat exchanger's tube in the boiler located above the firebox with the special steel brush which came with the stove by sweeping the brush lengthwise (vertically) up and down several times through each tube. There is a total of five tubes. Use protective gloves when cleaning because of soot. Clean when the stove is cold. See image 16.



Figure 16

Perform cleaning when the stove is cold. After cleaning the button should always be returned completely inwards so that only the button would be visible, and not the bar from the cleaning mechanism. See figure 16.

Use a vacuum cleaner to vacuum the ashes at the door opening, behind the glass.  
 -DOOR WITH GLASS (the door should be checked and cleaned from time to time):

**The stove and ash must be completely cool.**

The glass is made of high temperature resistant pyroceramics. If any damage is caused to the glass, replace the glass as soon as possible before you use the stove again. The glass must be replaced only by an authorized person.

- THE EXHAUST SPACE OF THE SMOKE FAN (it should be checked and cleaned every six months)

**The stove and ash must be completely cool.**

To clean the inner space for smoke discharge, first remove the cover i.e. plug at the bottom of the ash box casing and insert the vacuum cleaner hose through this opening, so that you may vacuum any residual ash and ensure the proper operation of the stove, Figure 17

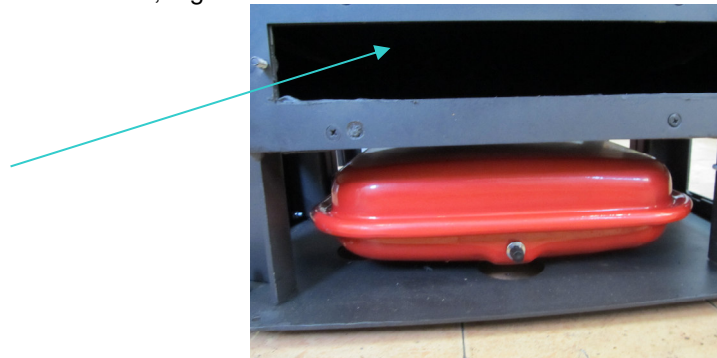

Figure 17

- GENERAL CLEANING AT THE END OF THE HEATING SEASON

**The stove and ash must be completely cool – unplug the power cable of the stove.**

At the end of the heating season, unplug the power cable of the stove for safety reasons. It is very important to clean and check the stove as it is explained above.

**The stove and ash must be completely cool.**

After a longer period of use, the asbestos-free tape (band) for sealing (packing) on the door may become detached from the door. This packing is stuck onto the door with high temperature resistant silicone. To repair this, fix the back (the back side of the tape) of the sealing tape with the use of high temperature resistant glue. This is very important for good door sealing.

## **6.2 CLEANING and MAINTENANCE (for maintenance workers)**

- THE FLUE CHANNELS – CHIMNEY (these should be cleaned every six months or after burning two tons of pellets)

**The stove and ash must be completely cool.**

This wind resistant flue channel (chimney) must be checked and cleaned each year. This should preferably be done at the beginning of the heating season. For the professional cleaning of these elements of the stove system you

should preferably contact authorized professionals. The spots that should be paid special attention to during cleaning and that should be cleaned particularly well are shown in Figure 18.

– INNER FIREBOX (every two weeks)

**The stove and ash must be completely cool.**

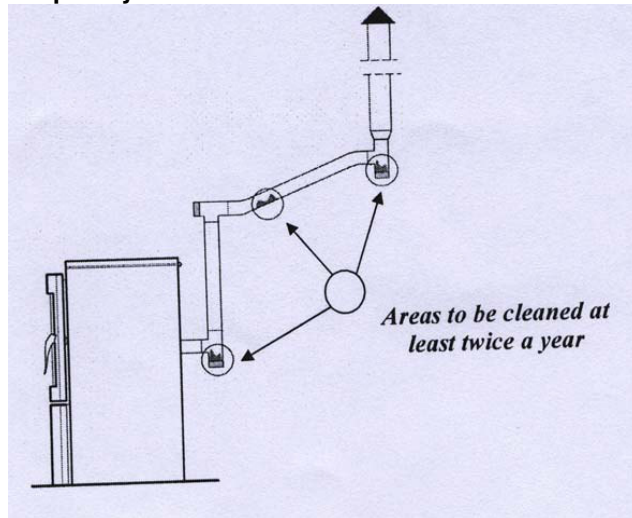

Figure 18. Spots to be cleaned at least twice a year

### **6.3 SPECIAL MAINTENANCE**

Your stove is a heat generator that uses pellets as solid biofuel. Due to this, special maintenance should be performed once a year.

These works, previously explained, should preferably be performed at the beginning of the heating season. The purpose of this special maintenance is to ensure the proper and efficient operation of the stove.

### **7.0 IMPORTANT SAFETY INFORMATION**

**You have bought a top quality product.**

The manufacturer will be always available to provide any further information you may need in relation to the label of the stove and the instructions for its assembly and installation in your geographical conditions. The proper installation of the stove in accordance with the instructions given in this Manual is very important for preventing dangers, fire or any defects or malfunctioning.

**The stove operates** with negative pressure in the combustion chamber. **Because of this you must ensure that the flue pipe is thermally sealed thoroughly.**

#### **DANGER**

**In the event of fire in the flue pipe**, evacuate all people and pets from the room, turn the power supply off immediately using the main switch in the house or by unplugging the power cable (the plug must always be easily accessible and free), and immediately call firemen.

#### **DANGER**

Classic fire wood cannot be used.

#### **DANGER**

**Do not use the stove for burning garbage.**

### **8.0 THE QUALITY OF FUEL PELLETS IS VERY IMPORTANT**

This stove is designed to use pressed wood (pellets) as fuel.

As there are many products of this type on the market, it is important to choose fuel pellets that are not dirty. You should use quality pellets that are compact and with little dust.

Ask your stove seller or manufacturer about the best pellets whose diameter should be around 6 to 7 mm and length around 30 mm. **The proper operation of the stove depends on the type and quality of fuel pellets as heat obtained from various types of products may have various intensities.**

The stove manufacturer shall not be liable for the use of fuel pellets of inadequate quality or for the poor operation of the stove due to such fuel.

#### **8.1 FUEL PELLET STORAGE**

Pellets must be stored in a dry place which is not too cold. In fact, cold and wet pellets (with a temperature of around 5 °C) decrease the thermal power of the fuel and require additional stove cleaning.

**PELLETS MUST NOT BE KEPT NEAR THE STOVE.** Keep them at least 2 metres away from the stove. Handle pellets carefully and avoid breaking them.

WARNING:

If sawdust or small – crumbled pellets are put into the funnel-shaped part of the stove i.e. the fuel tank, these may block the pellet (fuel) feeding. Such pellets may cause the electric motor driving the pellet feeding mechanism to burn out, or they may lead to damages to the electric motor reducer. If you see any such small, crumbled pellets at the bottom of the pellet tank or at the bottom of the screw conveyor when the tank is empty, vacuum them with a vacuum cleaner by inserting the vacuum cleaner hose through the openings of the pellet grate.

## 9. CONNECTION OF THE HYDRAULIC INSTALATION IMPORTANT!

**-Connection of the furnace to the hydraulic installation can be performed by qualified technician ONLY, and in accordance with the present legislation of the country in which the installation is performed.**

**ALFA PLAM disclaims any responsibility in case of material or physical damage, or in case of malfunction, if the above-mentioned recommendation were not implemented.**

Furnace is designed for both central heating for one storey and central heating for multiple storeys.

Furnace is prepared for closed heating system. All installations should be in compliance with SRPS regulations (Serbian technical regulations and standards).

### CONNECTING THE HYDRAULIC INSTALLATIONS

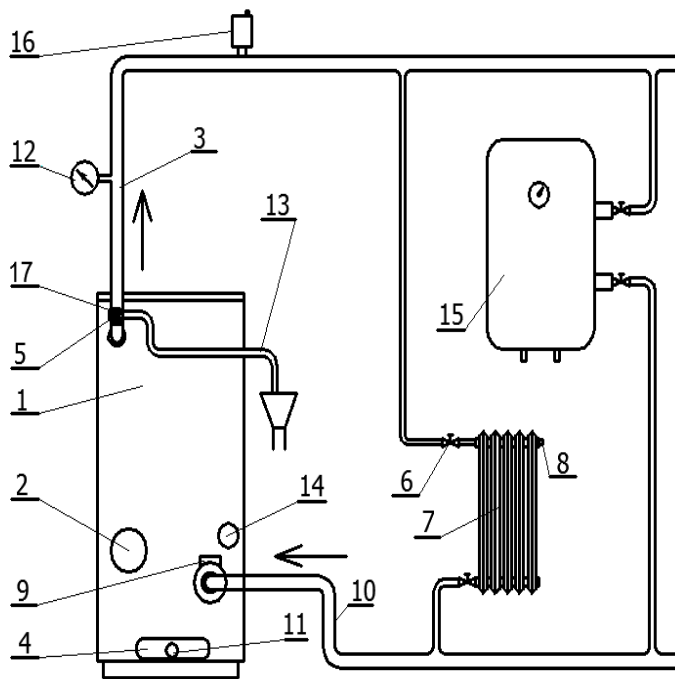

1. The COMMO Stove
2. Chimney connector
3. Distribution pipe
4. Expansion container (in the stove)
5. Safety valve (in the stove)
6. Radiator valve
7. Radiator
8. Breather valve
9. Circulation pump (in the stove)
10. Return pipe
11. Charging and discharging tap (in the oven)
12. Thermo hydrometer
13. Drain pipe from the safety valve
14. The feeding tube of the air to be combusted
15. Boiler

Back side of a boiler with all connections is shown in Fig. 19.



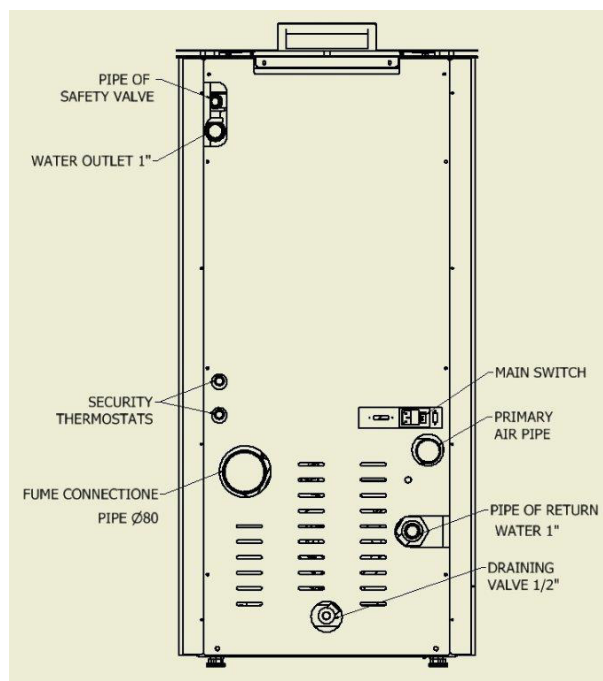

Figure 19

- Pos. water outlet is connection with external thread R1" for pressure line,
- Pos. pipe of return water is connection with external thread R 1" for return duct,

## 10. PRESSURE LINE AND RETURN DUCT

Pressure line and return duct outlets on the boiler are 1" wide and they should not be reduced or constricted before first forking. Use steel pipe 1" wide or copper pipe of 28 mm in outer diameter (or bigger).

During installation, pay special attention to pipes' gradients which should be 0.5% (5 mm per meter), and to ventilation of the system (boiler, pipes, radiators).

Put thermo manometer on pressure line that will show water pressure in the system and water temperature on the boiler outlet.

## 11. FURNACE BUILT-IN COMPONENTS

-Furnace has following built-in components:

- safety valve,
- circulating pump,
- automatic air vent valve,
- expansion tank and
- fill and drain cock.

It is not necessary to built mentioned components in. Complete furnace has a big advantage since you do not need additional room for components that are already built in.

### 11.1. SAFETY VALVE

Safety valve is positioned under the furnace lid on the pressure line. Inlet connector is R1/2". Valve opens at water pressure of 3 bars. To get to the valve, you must take the right lateral side off (facing the furnace). Connector of the safety valve outlet which is positioned on the rear side should be conducted into the sewers using pipes.

### 11.2. CIRCULATING PUMP

Furnace has built-in circulating pump Wilo type RS 25/6 – 3 positioned on the return duct R1". Power of the pump is 93W. It is electronically turned on and off according to the set water temperature.

Axle of the pump should be placed horizontally. Pay special attention to its position during connection with the installation.

To get to the pump, you must take the left lateral side off (facing the furnace).

### 11.3. AUTOMATIC AIR VENT VALVE

Automatic air vent valve is positioned on the pressure line, under the lid. Its purpose is to exhaust sufficient air from the boiler.

To get to the valve, you must take the right lateral side off (facing the furnace) .

**Valve safety cap should be loose, not too tight, so that the air could freely leave the boiler and remain of installation.**

#### 11.4. EXPANSION TANK

Furnace has built-in expansion tank with 10l volume. Function of the tank is pressure stabilisation in the boiler and in the heating system installation. Factory setting of the pressure in the tank is 1 bar.

#### 11.5. FILL AND DRAIN COCK

Purpose of the cock is filling and draining of the installation.

It is positioned on the rear bottom side.

Inlet connector is R1/2", and outlet connector has hose extension.

### 12. FILLING THE INSTALLATION AND PUTTING INTO OPERATION

Before heating season, entire heating system should be filled with water, ventilated, and the stove should be properly connected to the chimney, following above mentioned explanations.

Working water pressure is recommended to be 1 – 2 bars. Ideally between 1.2 and 1.6 bar.

Test pressure can reach 2.4 bars.

#### NOTE:

**Furnace must not be used without water. It must be connected to the installation system with radiators with minimum power of 8 KW.**

### 13. PRACTICAL GUIDELINES FOR USING HEATING SYSTEM

-All connectors must be properly sealed and tightened. There must not be any water leakage.

-Complete installation should be checked with water under the test pressure of 2.4 bars before putting into operation.

-System should be drained at least once because of the dirt inside it.

-Make sure that all valves between furnace and installation are open.

-Make sure to release air from the boiler and heating system prior to putting into operation.

-During ignition and cooling phases, furnace might change in volume in response to a change in temperature and that might cause crackling noises. That is absolutely normal, since the construction is made out of steel and it could not be considered as deficiency. A basic fabric setting guarantees proper functioning and prevents overheating.

### 14. FILLING WITH WOOD PELLET

Furnace is filled with fuel from the upper side by opening the lid. Put the wood pellets into the furnace; its capacity is approximately three 15 kg bags.

To simplify this procedure, split it to two segments:

-Put the half of the bag into the furnace and wait until pellets reach the bottom. Ignite the furnace.

-After the furnace starts to work normally, add the pellet as needed.

-Never remove the safety grill from the reservoir. During pellet filling, make sure that the pellet bag does not get in touch with hot surfaces.

### 15. DESCRIPTION AND FUNCTIONING OF THE FURNACE OPERATION CONTROLLER

#### 15.1. USER INTERFACE

The display unit enables communication with the controller by simple pressing on certain buttons.

##### 15.1.1. Push-button display

Display shows information about furnace operation status. Accessing the menu, user can get various kinds of information review and can make available adjustments according to level of access.

Figure 20 shows an example of a display representation.

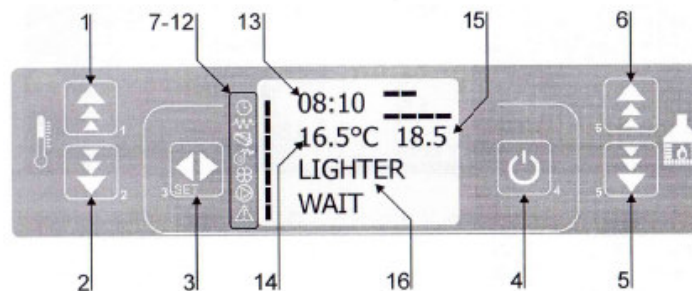

Figure 20

Buttons:

- 1 – increase of the temperature and the program functions for changing the date and time
- 2 – reduction of the temperature and the program functions for changing the date and time
- 3 – change of the program SET
- 4 – ON/OFF switching on/ switching off, exit from the program
- 5 – reduction of the heating intensity
- 6 – increase of the heating intensity
- 7 to 12 – it is described in figure 17
- 13 – hours
- 14 – room temperature indicator
- 15 – water temperature indicator
- 16 – information about the stove operation

Figure 21 gives description of symbols meaning when positioned on the left side of the display.

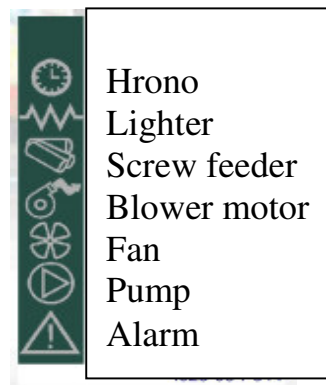

Figure 21

### 15.1.2. Push-button use

<b>Push-button</b>	<b>Description</b>	<b>Mode</b>	<b>Action</b>
1	<b>Increasing temperature</b>	SETTINGS	Set/increase value of chosen menu
		OPERATION/OFF	Increase value of room temperature
2	<b>Decreasing temperature</b>	SETTINGS	Adjust/decrease value of chosen menu
		OPERATION/OFF	Decreases room temperature
3	<b>Menu</b>	-	MENU access
		MENU	Access to the next level of submenu
		SETTINGS	Sets the value and moves on to the next menu item
4	<b>ON/OFF unblocking</b>	WORK	Two seconds long pressure turns the furnace on or off
		BLOCK	Unblocks the furnace and sets off mode
		MENU/ SETTINGS	Access to higher level of menu, set modulations are memorised
5	<b>Decreasing power</b>	OPERATION/OFF	Adjusts output power of the furnace
		MENU	Moves on to the next menu item
		SETTINGS	Moves back to the next submenu item, set modulations are memorised
6	<b>Increasing power</b>	MENU	Move son to the previous menu item
		SETTINGS	Moves on to the previous submenu, set modulations are memorised

Table 5

## 15.2. OPERATION MODE (USER)

### 15.2.1. Stove ignition

When the stove is connected to power supply, you should turn the switch which is at the back side of the stove to position 1. Then the following is shown in the display:

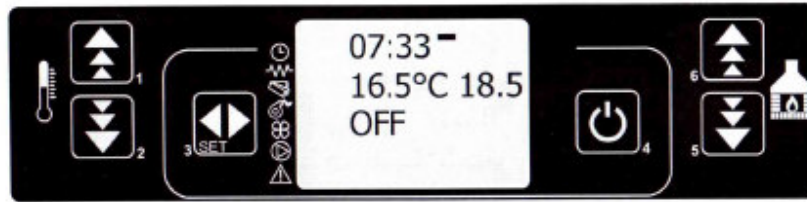

Figure 22

In order to ignite the stove, keep the button 4 pressed for few seconds, immediately after this we will get a START message on the display (figure 23) – we have started the stove.



Figure 23

Immediately after this we get the message LIGHTER WAIT (figure 24) – the lighter ignites and immediately after this the message LOAD PELLETS appears (figure 25) – pellets are being inserted. The next message is FIRE WAIT (figure 26) – we wait for the pellets to ignite and when the temperature of flue gases of 45°C is achieved, the message FLAME LIGHT appears (figure 27).

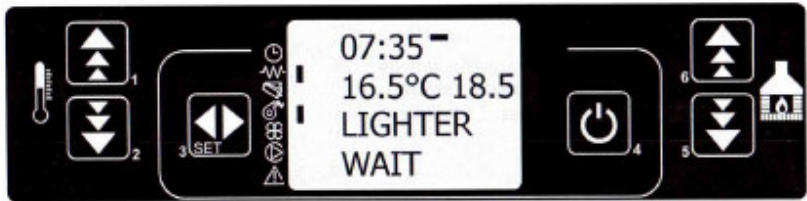

Figure 24

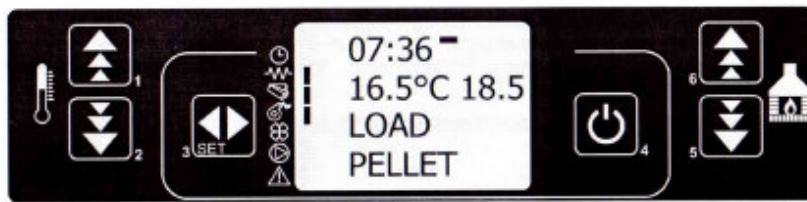

Figure 25



Figure 26

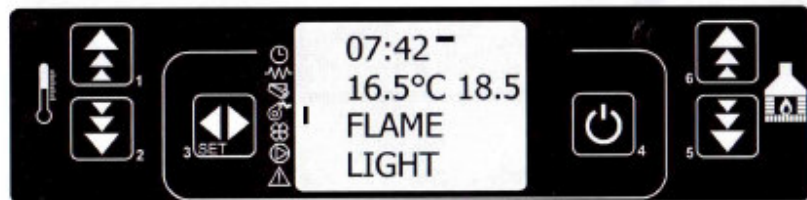

Figure 27

After this message, stable flame is established, the stove goes into operating mode and we get the message WORK (figure 28), whereupon the stove continues with a stable operating process.

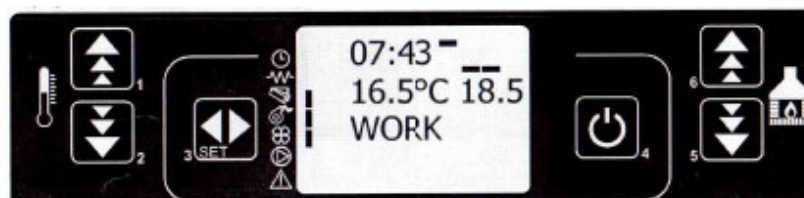

Figure 28

### 15.2.2 Failed ignition

Once a period of 20 minutes runs out, if the temperature of smoke did not reach the minimally allowed value of 45°C, the stove transfers to the state of an alarm, see point 15.6.3.

### 15.2.3 Stove in operational mode

If the stage of ignition is positively done i.e. if the temperature of flue gases had reached a value of 45°C for less than 20 minutes, the stove transfers to the operational mode WORK that represents its normal manner of functioning.

### 15.2.4. Adjustment of the temperature of the room and the water in the boiler

For the adjustment of the temperature of the room and the water in the boiler, it is sufficient to press the buttons 1 or 2. The display will show the current state of the set temperature ( $T_{SET}$ ).

The stove has been factory set with a temperature of water in the boiler of 65°C and at room temperature of 20°C.

By pressing the button 1, the message SET TEMP. WATER is shown (figure 29) i.e. adjusted value of the water temperature in the boiler. Thus, with button 1 we increase and with button 2 we reduce the value of the temperature and in this manner we adjust the desired value of the water temperature in the boiler. The temperature of water can be adjusted within the range from 40°C to 80°C. We recommend that you do not adjust the water temperature below 50 – 55°C due to possible condensation of the boiler, neither above 75°C.

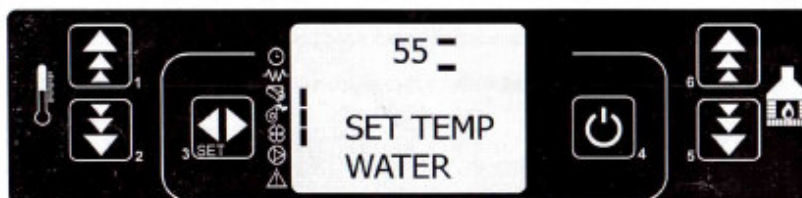

Figure 29

By pressing the button 2, the message SET TEMP. ROOM is shown (figure 30) i.e. set value of the temperature in the room. Thus, with button 1 we increase and with button 2 we reduce the desired value of the temperature in the room. The temperature in the room can be adjusted within the range from 7°C to 40°C.



Figure 30

### 15.2.5. The temperature of the room or the temperature of water in the boiler reaches the desired temperature

When the temperature of the room or the temperature of water in the boiler has reached the desired value ( $T_{SET}$ ), the heating power is automatically transferred to a minimal value, the stove transfers to an economical operational mode, whereupon savings in fuel are achieved, and the display shows the message WORK MODULAT as shown in figure 31:

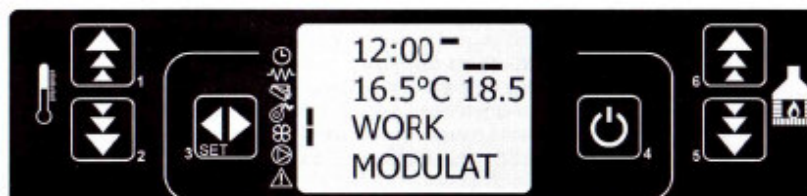

Figure 31

If after this, the temperature of the room or of the water in the boiler reaches a value which is for 4 °C bigger than the given ones ( $T_{SET} + 4^{\circ}C$ ), the mode STAND-BY activates, the stove temporarily switches off. It switches on again when the following conditions have been fulfilled:

$$T_{\text{prostorije}} < (T_{SET} - 4^{\circ}C)$$

### 15.2.6. Setting the stove power

When during the stage of ignition, the stove transfers to the stage of normal operation (stage WORK), it is possible to adjust the output power, that is, the intensity of heating. By pressing the buttons 5 and 6, the message SET OUTPUT appears, which means setting the output power. With button 6 we increase and with button 5 we reduce the power of the stove. Level 1 is minimal and level 5 is maximal power.

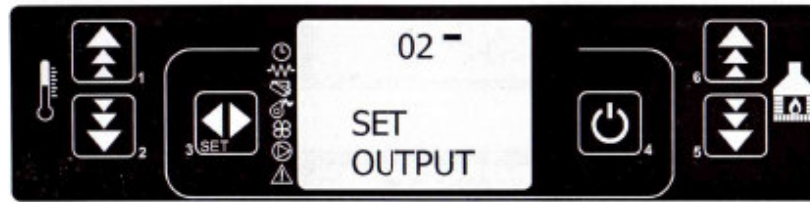

Figure 32

### 15.2.7. Cleaning of the boiler

During normal functioning in the operational mode, in intervals which have been set to 30 minutes, the mode "BOILER CLEANING" switches on, whose duration is 60 seconds. Then the process of inserting pellets stops and the burner is cleaned from unburned pellets, which has been followed by a message on the display that says CLEANING FIRE-POT.

### 15.2.8. Switching off the stove

In order to switch off the stove, it is sufficient to hold the button 4 pressed for about 2 seconds. The snail is immediately stopped and the smoke motor transfers to a higher speed and the following message appears on the display: CLEANING FINAL (figure 33). The stage CLEANING FINAL follows, which last from 10 to 20 minutes.

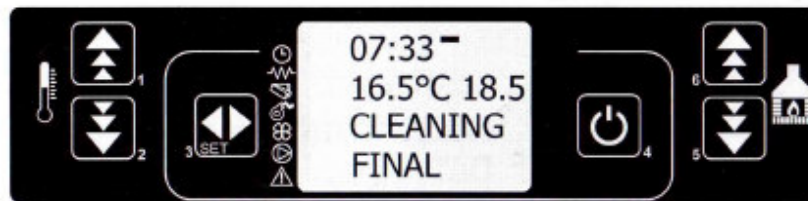

Figure 33

The activity of the smoke motor ends 10 minutes after the stove switches off and after the smoke temperature has fallen below the value of 70°C. When the stove switches off, a message OFF is shown on the display OFF (Figure 34).

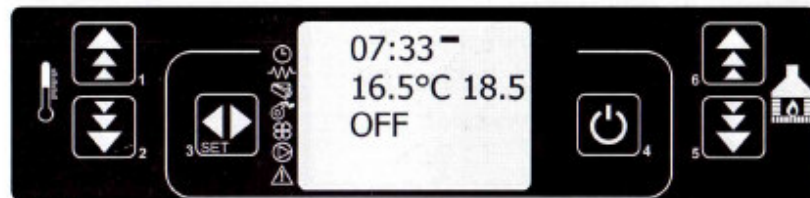

Figure 34

### 15.2.9. Reigniting the stove

It is not possible to reignite the stove before the temperature of the flue gases falls below the value of 45°C i.e. until the stove becomes cold.

## 15.5. APPEARANCE OF THE FLAME – FIRE

You should pay attention to the shape, color and nature of the fire.

**The shape** of fire should be „lively”, elongated and wide.

**The color** of fire should be between yellow, light yellow and white color.

**The nature** of fire should be „lively”.

## 15.5. MENU

By pressing the button 3 (MENU), an access to the menu is provided.

It is divided into different items and levels that enable access to the adjusting and programming of the card.

**The items of the menu that approve access to the technical programming are protected with a key.**

### 15.4.1. User's menu

The following review shortly describes the structure of the menu, in this paragraph only explaining the selections that are available to the user. The Menu is accessed through the button 3, and then the same button is used for access to the next level of the submenu and in the end the button 3 is used for setting a value and transition to the next menu item.

The button 6 is used for transition to the previous submenu and the adjusted settings are memorized. The button 5 is used for transition to the next submenu and the adjusted settings are memorized. The button 4 is used for transition to higher menu level, and the adjusted settings are memorized.

#### 15.4.2. Menu 01 – setting the time

This menu is used for setting the current time and date on the display. The electronic card is equipped with a lithium battery that enables the internal clock to function longer than 3/5 years. In order to set the time, it is required to access the menu for setting the time and date. Press the button SET and the button 5 to reach the menu 01 as shown in figure 35:



Figure 35

Press the button SET and the buttons 1 or 2 to set the exact day in the week (MONDAY, TUESDAY...) (figure 36)  
 Press the button SET and the buttons 1 and 2 to set the clock time (figure 37).

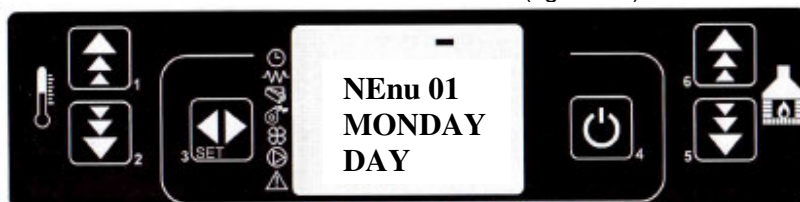

Figure 36



Figure 37

Press the button SET and the buttons 1 and 2 to set the minutes (figure 38).  
 Press the button SET and the buttons 1 and 2 to set the month in the year (figure 39).  
 Press the button SET and the buttons 1 and 2 to set the day in the month (figure 40).  
 Press the button SET and the buttons 1 and 2 to set the year (figure 41).  
 Upon terminating with these settings, return to the initial menu by pressing the button 4.

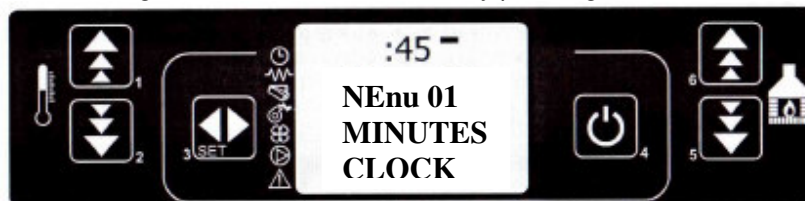

Figure 38



Figure 39

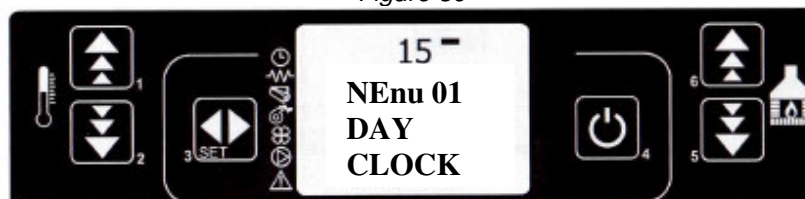

Figure 40

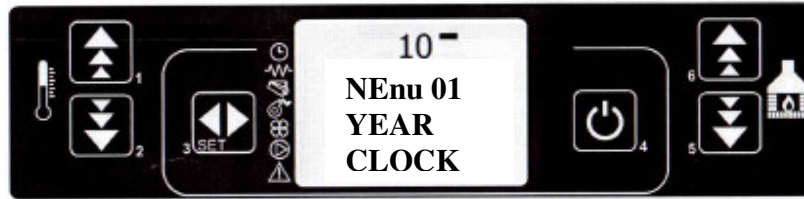

Figure 41

**15.4.3. Menu 02 – programming of the stove operation**

There are three types of programming of the stove operation:

- Daily programming
- Weekly programming
- Weekend programming

**Daily programming**

This enables setting of the daily functions of the chronothermostat. The stove can be ignited and switched off twice as desired and this is regulated by programming, having in mind that sufficient time is required between the switching off and the new ignition so that the stove could cool. It is necessary that the time and date are precisely set (menu 01). The functions of switching on and switching off of the stove depend on these actions, so for this reason you must compulsorily adjust the exact time. First press the button SET and the button 5 and enter in the menu 02 as shown in figure 42:



Figure 42

Press the button SET, the shown indication is same as in figure 43:

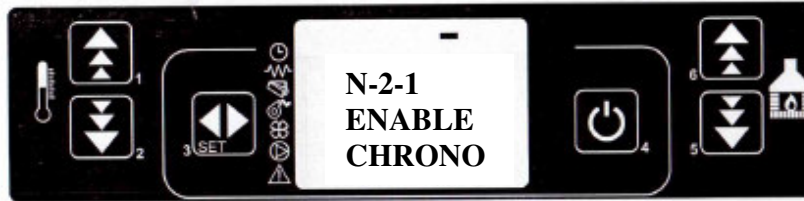

Figure 43

Press the button SET, the shown indication on the display is same as in figure 44. By pressing the button 1 we are switching on the chronothermostat (on) as shown in figure 45.



Figure 44

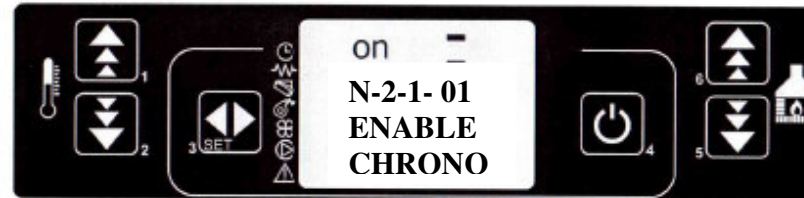

Figure 45

Press button 4 and then button 5, and then the display will show the same indication as in figure 43:



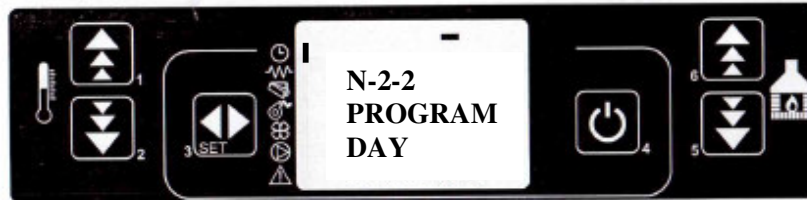

Figure 46

Press the button SET twice and the representation on the display will be the same as in figure 47. The buttons 1 or 2 are used for adjusting the time of the first ignition of the stove during the day. By pressing the button SET, the display will have the same appearance as in figure 48 and the time of the first switching off of the stove is set by pressing the buttons 1 or 2.

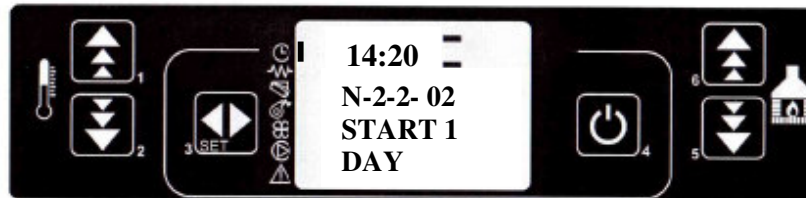

Figure 47

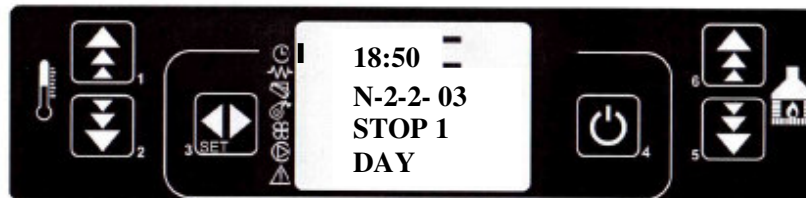

Figure 48

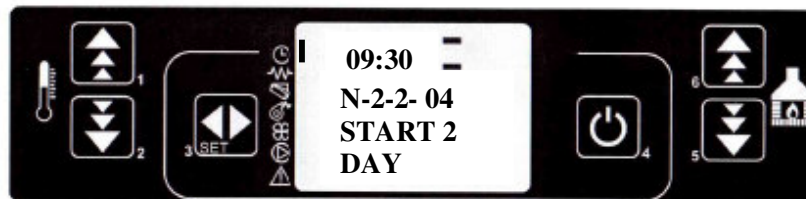

Figure 49

By pressing the button SET, a transition is made towards setting of another program. With the button 1 we adjust the time of ignition of the stove (figure 49). By pressing the button SET we set the time of switching off of the stove (figure 50). After the terminated setting, with the button 4 we return to the basic menu and an indicator will appear on the display that the programming is active.

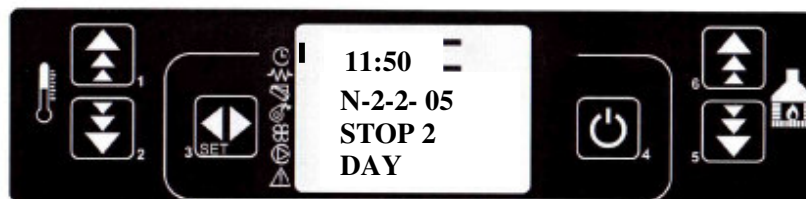

Figure 50

### Weekly programming

The weekly programmer has 4 independent programs at its disposal (4 times switching off and ignition). These 4 programs can be combined for each day in the week, separately i.e. whether some of them will be active or not (OFF or ON). Make sure that the programs are carefully set in order to avoid overlapping of the time of switching on and switching off.

**Attention: carefully perform the programming, generally avoiding overlapping of the time activation and/or deactivation on the same day in different programs.**

The programming procedure is the following:

The first four steps during programming are the same as in the setting of the daily program (figure 42-45). Press the button 4 and then press the button 5 twice and the display will have the same appearance as shown in figure 51.

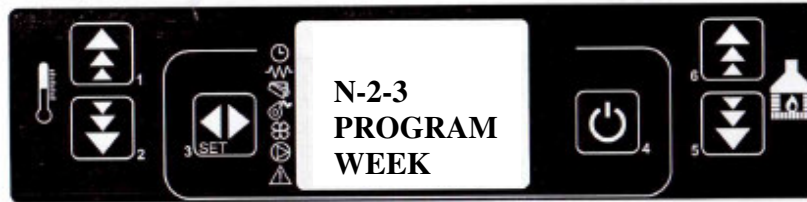

Figure 51

Press the button SET and then the button 1 and activate the weekly programming (On) as shown in figure 49.

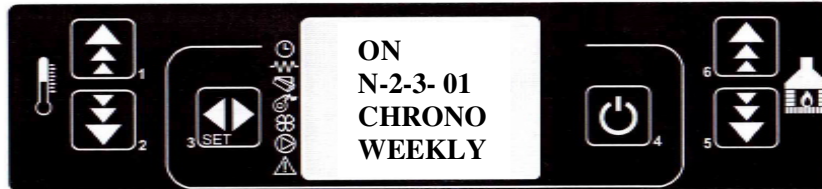

Figure 52

By pressing the button SET and then the button 1 we are setting the starting time of the stove operation in the first program, as shown in figure 50. Repeat the same procedure and set the time of switching off of the stove in the first program as shown in figure 51.

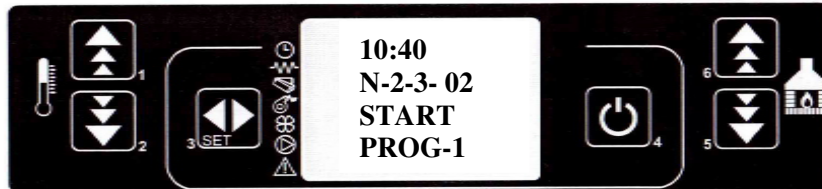

Figure 53

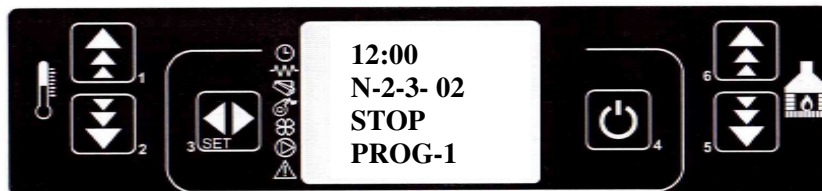

Figure 54

By pressing the button SET and the button 1 we activate (ON) or deactivate (OFF) the program 1 for the corresponding day in the week starting from Monday, up to Sunday as shown in figures 55 and 56. The transition from day to day is performed by pressing the button SET.

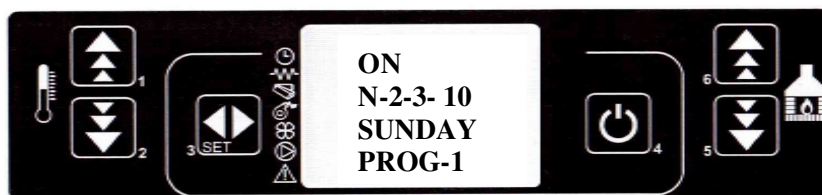

Figure 55

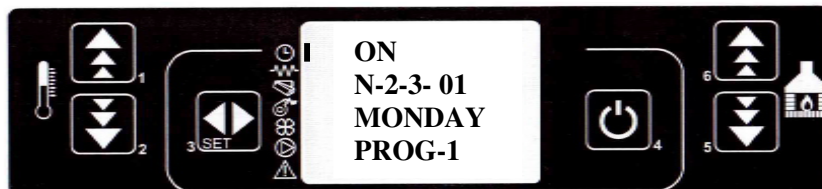

Figure 56

By pressing the button SET, a transition is made towards setting of another program and its activation for every day in the week separately (in the same manner as it was done for program 1). Repeat the same procedure for the remaining two programs (program 3 and 4). The indicator that the programming is active will be shown in the display.

**Attention: Deactivate the daily program if you want to use weekly programming.**

### Weekend programming

The weekend programming enables programming, switching on and switching off of the stove (twice a day) during the weekends (Saturday and Sunday). Activate the weekend programming only if the daily and weekly programming has been deactivated.

The first four steps during programming are the same as in the daily programming (figures 42-45). Press button 4 and then press button 5 three times and the display will look the same as shown in figure 57.



Figure 57

By pressing the button SET, we activate the weekend program as shown in figure 58.



Figure 58

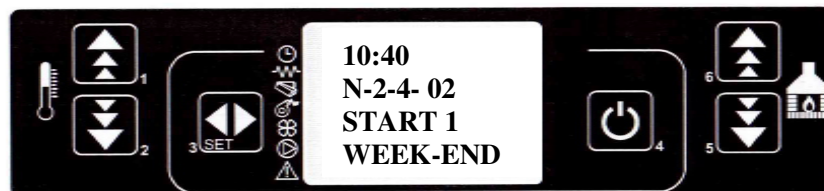

Figure 59

By pressing the button SET and then the button 1, we adjust the time of the stove's first ignition as shown in figure 59. Another pressing of the button SET and the button 1 sets the time of switching off of the stove and the display will look the same as in figure 60.



Figure 60

The same procedure is applied for programming of another weekend program, figure 61 and 62.



Figure 61

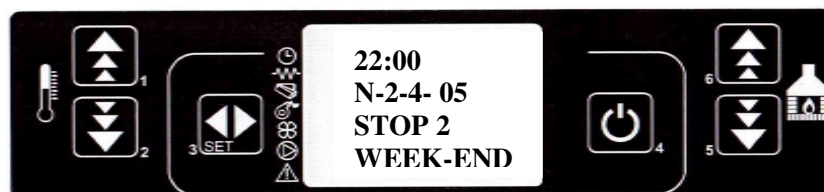

Figure 62

After these adjustments, we return to the main menu by pressing the button 4.

**SUGESTION: to avoid confusion and unwanted turning on and off, activate only one program if you are not sure what do you want to accomplish.**  
**Deactivate daily if you wish to engage weekly program. Weekend program always keep inactive, if using weekly program in levels 1, 2, 3 and 4.**  
**Activate weekend program only after deactivating the weekly program.**

#### 15.4.4. Menu 03 – language selection

Provides selection between available languages.

<i>Level 1</i>	<i>Level 2</i>	<i>Value</i>
<b>Menu 03 – choose language</b>		
	Menu 03-01 – Italian	Set
	Menu 03-02 – French	Set
	Menu 03-03 – English	Set
	Menu 03-04 – German	Set

**Attention: English language is set. We recommend that in menu 3 keeps fabric settings.**

#### 15.4.5. Menu 04 – stand-by mode

When you choose ON, “STAND-BY” mode activates that shuts the furnace down after the room temperature reaches 4°C higher value from set temperature ( $T_{SET}$ ) in a time period longer than 2 minutes.

After shutting down caused by this setting, re-ignition will be possible when following condition is met:  
 $T_{room} < T_{SET} - 4^{\circ}C$

If the option ON is activated in stand-by menu, choosing options 1, 2 or 3 it is possible to set that stand-by mode activates following temperatures:

- 1 – Room temperature
- 2 – Water temperature in the boiler
- 3 – Room thermostat that can measure room temperature (if available).

**Attention: We recommend that stand-by mode in menu 4 keeps fabric settings.**

#### 15.4.6. Menu 05 – sound signal mode

Choosing “OFF” option acoustic signalisation is disabled.

#### 15.4.7. Menu 06 – initial filling

Enables pre-charge with pellets in shut-down and cold furnace for 90 seconds. Start with pressing push-button P1 and stop with pressing P4.

#### 15.4.8. Menu 07 – furnace status

Shows current furnace status displaying statuses of different devices connected to it. It shows: Flue gasses, temperature, blower motor RPM etc.

#### 15.4.9. Menu 08 – technical settings

Access to this menu is not available to the User.

### 15.5. ALARMS

In case of malfunction, controller turns on and warns for irregularities with different kinds of alarms. Following alarms are envisaged:

<b>Source of alarm</b>	<b>Display message</b>
Smoke temperature probe	<b>PROBE EXHAUST</b>
Smoke temperature exceeding	<b>HOT EXHAUST</b>
Ignition failure	<b>NO LIGHTIN-</b>
Fire extinguishing during work mode	<b>NO PELLET</b>
Power outage	<b>BLACK OUT</b>
Screw feeder safety pressure stat	<b>FAILURE DEPRESS</b>
Safety thermostat	<b>SAFETY THERMAL</b>
Smoke fan malfunction	<b>FAN FAILURE</b>
Screw feeder safety	<b>ALARM TRIAC CO.</b>
Flow meter malfunction	<b>PRESS WATER</b>

Table 6

**After every alarm sounding, furnace automatically shuts down**

Alarm is activated after 30 seconds and pressing the push-button P4 stops it.

**15.5.1. Smoke temperature probe alarm**

It activates in case of smoke probe malfunction. During alarm, furnace automatically shuts down.

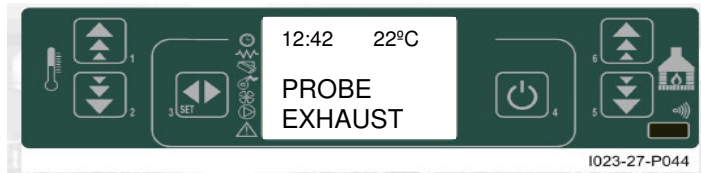

Figure 63

**15.5.2. Smoke temperature exceeding alarm**

It activates in case when smoke probe detects temperature higher than 280°C. On display appears message as shown in the following figure:



Figure 64

During alarm, furnace automatically shuts down.

**15.5.3. Ignition failure alarm**

It activates in case of ignition failure.

Shutdown procedure immediately starts.



Figure 65

**15.5.4. Alarm for fire extinguishing during work mode**

If the fire extinguishes during working mode, and smoke temperature fell below working threshold minimum (45°C), alarms activates:



Figure 66

Shutdown procedure immediately starts.

**15.5.5. Alarm for screw feeder safety pressure stat**

If pressure stat (air input meter) detects that pressure value is below activation threshold, pressure stat stops screw feeder power supply. Message: "Alarm Failure Depress" appears and system stops.



Figure 67

**15.5.6. Safety thermostat alarm**

If general safety thermostat detects temperature higher than allowed, it stops screw feeder power supply. Message ALARM **SAFETY THERMAL** appears and system stops.



Figure 68

**Boiler overheating alarm or screw feeder temperature:** this alarm activates when the boiler temperature or screw feeder temperature is too high, and then message "SAFETY THERMAL" appears. This is additional safety device. To return to normal working mode, you should wait for furnace to shut down (smoke fan works). Cooling lasts for twenty minutes. After that, renew safety thermostat function that blocked the furnace (take plastic cap off and press thermostat button until silent metal noise sounds). It is located on the rear side of the furnace (Figure 69) and then press push-button P4, hold for 3 seconds until furnace changes back to ON mode. Upper thermostat blocks the furnace operation when the water in the boiler reaches 100°C, and bottom thermostat when screw feeder reaches temperature of 80°C.

NOTE: If any of two previously mentioned alarms activates, check if the chamber is not clogged with ashes or that chimney is not partially clogged.

Main switch with power cable is shown in figure 70.



Figure 69



Figure 70

### 15.5.7. Alarm for blower motor (fan) malfunction

If the blower motor (fan) breaks, furnace shuts down and message ALARM FAN FAILURE appears, as in following figure.

Shutdown procedure immediately starts.

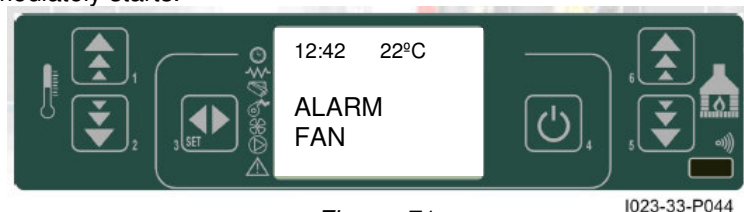

Figure 71

### 15.5.8. Power outage occurs (block-out)

After AC power fails and depending on status the furnace was in, following can occur:

Previous status	Duration of power outage status	New status
Off	any	Off
On	< 30 sec	On
Pellet filling	< 30 sec	Pellet filling
Waiting for flames	< 30 sec	Waiting for flames
Work	< 30 sec	Work
Boiler cleaning	< 30 sec	Boiler cleaning
Off	< 30 sec	Off

Table 7

In all cases when duration of power outage was longer than 30 seconds, furnace shuts down. When AC power is on again (the power outage was longer than 30 seconds) then the following is shown in the display (figure 69):



Figure 72

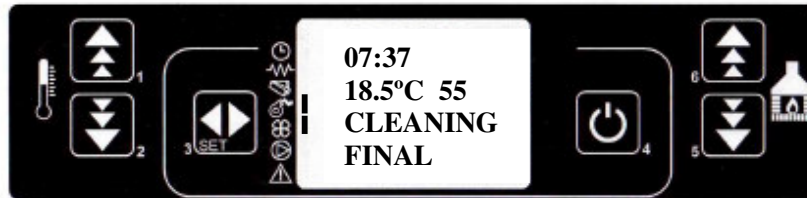

Figure 73

In order to cancel the alarm, it is necessary to hold the button 4 pressed for about 2 seconds and the smoke motor transfers to a higher speed and the following message appears on the display (figure 73). After finishing that process, the display will show the indication as in figure 74 and the stove will be ready for new start.



Figure 74

### 15.6. CONNECTION SCHEME

Bellow is given a typical connection scheme.

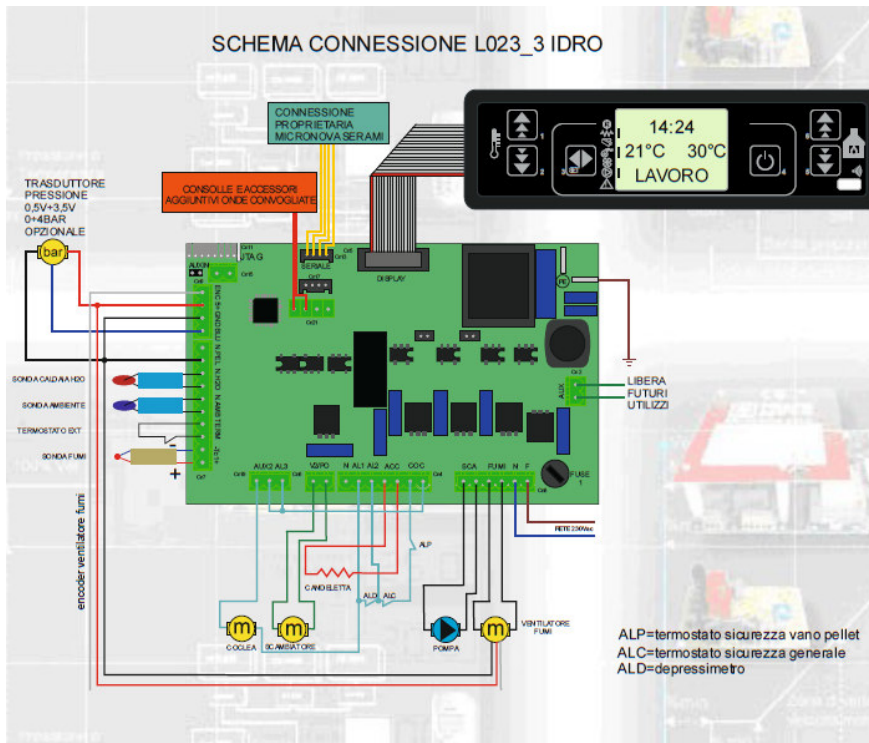

Figure 75

## 16. SECURITY MEASURES

Furnace is equipped with following safety devices:

### -PRESSURE REGULATOR

Controls the pressure in the chimney. It stops transport spiral for the pellet when the outlet is clogged or when it faces pressure (draught)

### -FLUE GASES TEMPERATURE SENSOR

Measures the temperature of the flue gasses and allows furnace ignition or stops it if the flue gasses temperature goes below set value.

### -CONTACT THERMOSTAT IN THE FIREBOX OR ON THE SCREW FEEDER CASE

When a temperature exceeds safety values, furnace immediately shuts down.

### - CONTACT THERMOSTAT IN THE BOILER

When a temperature exceeds safety values, furnace immediately shuts down

### -WATER TEMPERATURE SENSOR

When water temperature gets close to 85°C, sensor runs cooling cycles or automatically shuts the furnace down using "ECO-STOP" option, in order to avoid blocking the temperature sensor.

### -ELECTRICAL SAFETY

Furnace is protected from power surges with standard fuse located on control panel on the rear side of the furnace. Rest of the fuses are located on the rear side of the furnace in order to protect motherboard (integrated cards and heat exchanger cards).

### -FLUE GASSES FAN

If the ventilator stops, motherboard blocks the pellet feed and emits alarm signal.

### -HELICAL GEARED MOTOR

When helical geared motor stops working, furnace continues to work until the flame does not extinguish and until the minimum cooling level is not reached.

### -TEMPORARY OUTAGE

After short outage, furnace automatically starts cooling process.

### -NO IGNITION

If during ignition there is no flame, furnace automatically changes to alarm status.

## 17. MALFUNCTION - CAUSES - SOLUTIONS

PROBLEMS	POSSIBLE CAUSES	SOLUTIONS
<b>Wood pellets are not in the firebox, in combustion chamber.</b>	<ol style="list-style-type: none"> <li>1. Wood pellet reservoir is empty.</li> <li>2. Transport spiral is blocked.</li> <li>3. Helical geared motor is broken.</li> <li>4. Electric card is broken.</li> </ol>	<ol style="list-style-type: none"> <li>1. Fill the reservoir.</li> <li>2. Empty the reservoir and unblock the spiral – screw feeder</li> <li>3. <i>Replace helical geared motor</i></li> <li>4. <i>Replace electric card</i></li> </ol>
<b>Fire is not burning or furnace automatically shuts down.</b>	<ol style="list-style-type: none"> <li>1. Wood pellet reservoir is empty.</li> <li>2. Combustion chamber is not filled with wood pellets.</li> <li>3. Safety temperature probe activation.</li> <li>4. Hatch is not properly closed or sealing cord is worn.</li> <li>5. Inadequate wood pellets.</li> <li>6. Poor supply of wood pellets.</li> <li>7. Combustion chamber is filthy.</li> <li>8. Chimney is clogged.</li> <li>9. Interference or malfunction on pressure stat.</li> <li>10. Smoke fan motor is broken.</li> </ol>	<ol style="list-style-type: none"> <li>1. Fill the reservoir with wood pellets.</li> <li>2. See previous solution.</li> <li>3. Let the furnace cool down and then turn it on again. If the problem persists, contact technical department.</li> <li>4. Close the hatch or replace sealing cord.</li> <li>5. Change the type of wood pellets and choose one with manufacturer's approval.</li> <li>6. Check dosage and settings.</li> <li>7. Clean the combustion chamber following instructions manual.</li> <li>8. Clean the chimney.</li> <li>9. Replace pressure stat.</li> <li>10. <i>Check the motor and replace it if needed.</i></li> </ol>
<b>Furnace works for several minutes and then shuts down.</b>	<ol style="list-style-type: none"> <li>1. Ignition phase is not over.</li> <li>2. Temporary outage.</li> <li>3. Chimney is clogged.</li> <li>4. Interference or malfunction on temperature probe.</li> <li>5. Spark plug is damaged.</li> </ol>	<ol style="list-style-type: none"> <li>1. Repeat ignition.</li> <li>2. See previous instruction.</li> <li>3. Clean the chimney.</li> <li>4. <i>Check or replace the probe.</i></li> <li>5. <i>Check or replace the sparkle plug.</i></li> </ol>
<b>Wood pellets form</b>	<ol style="list-style-type: none"> <li>1. Lack of air for combustion.</li> </ol>	<ol style="list-style-type: none"> <li>1. Clean combustion chamber and</li> </ol>



<b>layer of sediment in combustion chamber. Hatch glass is soiled and the flame is weak.</b>	2. Wet or inadequate wood pellets. 3. Smoke fan system motor is broken.	check if all openings are open. Clean chimney as well. Check if the air intake is not clogged. Check sealing cord on the hatch. 2. Change wood pellet type. 3. Check motor and replace it if needed.
<b>Smoke blower motor does not work.</b>	1. Furnace power supply is interrupted. 2. Motor is damaged. 3. Motherboard is damaged. 4. Control panel is not working.	1. Check the supply of the grids and resistance to melting safety device. 2. Check motor and capacitor and replace if needed. 3. <i>Replace electronic card.</i> 4. <i>Replace control panel.</i>
<b>Furnace works with maximum capacity in automatic mode.</b>	1. Thermostat is set to the maximum. 2. Room temperature thermostat always measures cold air. 3. Temperature probe is damaged. 4. Control panel is damaged or out of function.	1. Set thermostat temperature again. 2. Change the probe position. 3. <i>Check the probe and replace if needed.</i> 4. <i>Check control panel and replace if needed.</i>
<b>Furnace can not be ignited.</b>	1. Power supply problem. 2. Wood pellets robe is blocked. 3. Pressure stat does not work (reports blockage). 4. Smoke fan or chimney is clogged.	1. Check if the plug is plugged in and if the main switch is fixed to position "I". 2. Unblock the probe by moving thermostat in the rear. If blocks again, replace the thermostat. 3. Replace pressure stat. 4. Clean chimney outlet.

Table 8

## **18.0 INFORMATION ON THE DISPOSAL (DISCARDING) AND DISASSEMBLY (DISMANTLING) OF THE STOVE**

The disassembly and disposal of (an old, used) stove is the sole responsibility of the owner of the stove. The owner of the stove must observe the applicable legal regulations of his own country related to the safety and protection of the environment. The disassembly and disposal of the stove may be delegated to a third party provided that this third party is a company authorized for the collection and disposal of such materials.

**NOTICE:** *In all cases you must observe the applicable legal regulations of the country in which the stove is installed, related to the disposal of such materials (things) and, if necessary, report the disposal of such things.*

### **CAUTION**

*The disassembly of the stove may only be performed when the chamber of the stove is not in operation and when the stove is unplugged (there is no electric power supply).*

- *Remove all the electric parts,*
- *Discard the batteries of the electronic card and remote controller into adequate containers in accordance with the standards,*
- *Separate the batteries to be kept from the electronic card,*
- *Disassemble the structure of the stove engaging an authorized company.*

### **CAUTION**

*The disposal of the stove at public places represents a serious threat to people and animals. In such cases, the owner shall be liable for any injuries of people and animals.*

*When the stove is disassembled, the EC mark, this Manual and any other documents related to the stove must be destroyed.*

## **19.0. TIME OF GUARANTEED SERVICING**

This implies the period during which we guarantee the service, accessories and space parts, starting from the day of purchase of the device.

The time of guaranteed servicing is in accordance with the valid legal regulations.

In case of change of the model and the design of the device, the term for change of parts that have modified design is within the legal term.

After this term we provide the modified parts in the new designs.

### **19.1. CONDITIONS OF THE GUARANTEE**

**The guarantee of the product is valid within the legally defined term.**

**The guarantee is not valid for the glass, the glass-ceramic panel and the physical damages that have occurred after purchase.**

**THE MANUFACTURER RETAINS ALL THE RIGHTS TO MAKE CHANGES.**

The device will properly function within the guaranteed term only if it is used in accordance with these guidelines for connection and application.

The guarantee cases to apply if it is determined that:

-the connection or the repair of the product was performed by an unauthorized person, that is, if unoriginal parts have been embedded,

- if the device has not been properly used in accordance with these guidelines,

- if some mechanical damaging of the device occurred during usage,

- if the repairs of defects were performed by an unauthorized person,

- if the device has been used for commercial purposes,

- if the damage has occurred during transportation after the device was sold,

- if the defects occurred due to improper mounting, improper maintenance or mechanical damaging by the buyer,

- if the defect occurred after too strong or insufficient power, as well due to force major.

We can repair the defects of Your device also outside the guaranteed period, with original spare parts for which we also provide a guarantee under the same conditions.

This guarantee does not exclude or affect the rights of the customer in regard to the conformity of the goods pursuant to the legal regulations. If the delivered product does not conform to the agreement, the customer has the right to ask the seller to repair that lack of conformity without any reimbursement, by repair or change of the product in accordance with the valid legal regulations.

## CONTENT

0.0 Technical Characteristics of the Stove

1.0 The Purpose of this Manual

1.1 Updating

2.0 The Responsibility of the Manufacturer

2.1 The Basic Characteristics of the User

2.2 The Transportation and Use of the Stove – Handling

2.3 The Responsibility of the Installer

3.0 The Installation – Incorporation of the Stove

3.1 Placing the Stove

3.2 The Smoke Discharge System

3.3 The Insulation and Diameter of the Openings (Holes) on the Roof (or on the Wall)

3.4 The Intake of Combustion Air

3.5 The Connection to the Electric Power Supply

4.0 Important Instructions

5.0 Warning of the Safety Measures for the Maintenance Workers

5.1 Warning of the Safety Measures for the User

6.0 Standards for Safe Starting up and Cleaning the Stove

6.1 Routine Cleaning and Maintenance Performed by the User of the Stove

6.2 Inspection and Maintenance Places

6.3 Special Maintenance

7.0 Important Safety Information

8.0 The Quality of Fuel Pellets

8.1 Fuel Pellet Storage

9.0. Connection of the hydraulic installation

10.0. Pressure line and return duct

11.0. Furnace built-in components

11.1. Safety valve

11.2. Circulating pump

11.3. Automatic air vent valve

11.4. Expansion tank

11.5. Fill and drain cock

12.0. Filling the installation and putting into operation

13.0. Practical guidelines for using heating system

14.0. Filling with wood pellets

15. Description and functioning of the furnace operation controller

15.1. User interface

15.2. Operation mode

15.3. Flame appearance

- 15.4. Menu
- 15.5. Alarms
- 15.6. Connection scheme
- 16.0. Security measures
- 17.0. Malfunctions – causes – solutions
- 18.0 Information on the Disposal (Discarding) and Disassembly of the Stove
- 19.0 Time of guaranteed servicing

